

版数 REV.	年月日 DATE	DCN NO.	変更内容 DESCRIPTION	製図 DR.	担当 CHK.	査閲 APPD.	承認 APPD.
------------	-------------	---------	---------------------	-----------	------------	-------------	-------------

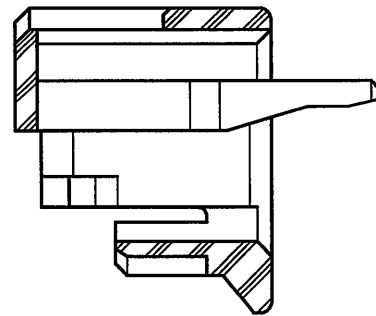

SECT. A-A
(SCALE 5:1)

(MATERIAL MARK)

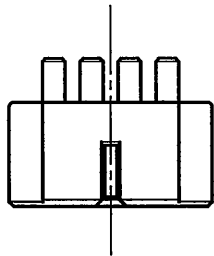
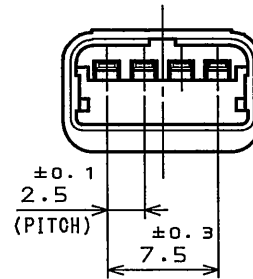
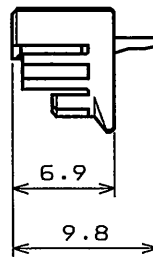
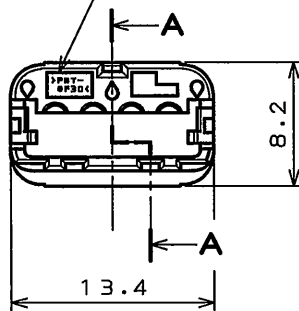

特別管理品目
SPECIAL CONTROL ITEM
MX (SRS)

DOF-0-211E(03.08)

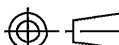
1	FRONT RETAINER	1	PBT-GF30	—	COLOR: BLACK
符号 NO.	名称 DESCRIPTION	個数 QTY.	材料 MATERIAL	仕上 FINISH	備考 REMARKS
仕様書 (SPECIFICATION) JAOS-10220 JAHL-10220		第1版 (ORIGINAL DATE) 4.Feb.2005		名称 (TITLE) MX36004XF3	
公差 (GENERAL TOLERANCE)		製図 DR.	H.HASHIMOTO	JAPAN AVIATION ELECTRONICS INDUSTRY, LTD. 	
寸法 (DIMENSION)		担当 CHK.	M.WATANABE		
角度 (ANGLES)		査閲 APPD.	—		
		承認 APPD.	A.Chino / Y.HIROSE		
· ±0.8	×° ±			FRONT RETAINER	
·X ±0.4	×°X ±			シリーズ (SERIES) 尺度 (SCALE)	
·XX ±0.1				MX36 2:1	
·XXX ±				図面番号 (DRAWING NO.) SJ102923	
				日本航空電子工業株式会社 JAE	
				版数 (REV.) 1	